



ECHO® IN-LINE TRAILER BRAKE CONTROLLER INSTALLATION MANUAL

51200

TABLE OF CONTENTS

Controls & Components	Page 1
Before You Begin	Page 2
Wiring Diagram	Page 2
Mounting the Main Module	Page 3
Downloading the Mobile Application	Page 4
Initial Setup for Bluetooth Connection	Page 4
Application Setup	Page 5
Adding a Profile	Page 5
Activating a Profile	Page 5
Modifying or Deleting a Profile	Page 5
Configuring Profile Settings	Page 6
Test Drive & Adjustment	Page 7
LED Status Indicator	Page 7
Troubleshooting Guide	Page 8

NOTICE This device contains license-exempt transmitter(s) / receiver(s) that comply with Innovation, Science and Economic Development Canada's license-exempt RSS(s). Operation is subject to the following two conditions:

1. This device may not cause interference.
2. This device must accept any interference, including interference that may cause undesired operation of the device.

CONTROLS & COMPONENTS

1. Main module
2. Main module adhesive pad
3. Wiring harness
4. Six 6" zip ties
5. Two 14-1/2" zip ties
6. Four self-tapping screws

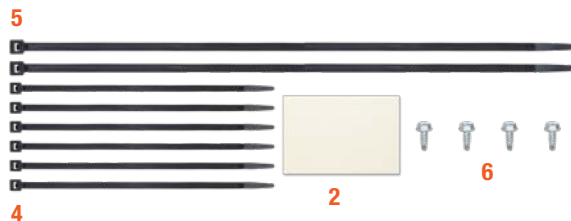

BEFORE YOU BEGIN

One or more of the following may be needed for installation:

ⓘ ⚠ IMPORTANT: Read and follow installation manual carefully. Failure to do so could result in damage to the brake control unit, loss of trailer brakes or poor brake performance.

Disconnect the electrical plug between the trailer and tow vehicle before testing a breakaway switch. Failure to disconnect may damage the brake control unit.

⚠ WARNING The main module must be mounted firmly in place. Failure to do so could lead to improper operation and / or brake failure.

This product IS NOT compatible with Apple CarPlay or Android Auto, however, it will not interfere with these features.

This product is designed to provide a Bluetooth connection, without obstructions, up to 50 ft. connection may also be limited by the Bluetooth signal of your device.

⚠ WARNING Avoid distracted driving. Only make adjustments when the vehicle is stationary. Please adhere to all applicable traffic laws and motor vehicle safety regulations including, but not limited to, all laws and regulations prohibiting the use of handheld devices while operating a motor vehicle.

⚠ WARNING Echo® App must be operating in the foreground of your cell phone applications. Operating the App in the background of your cell phone applications may cause delays in braking response when using the manual override button.

⚠ WARNING Do not mount the Echo® near the exhaust pipe. Failure to do so may result in heat damage, loss of functionality and risk of fire.

📢 NOTICE Prior to driving, test all trailer lights while the trailer is plugged into the Echo®.

WIRING DIAGRAM

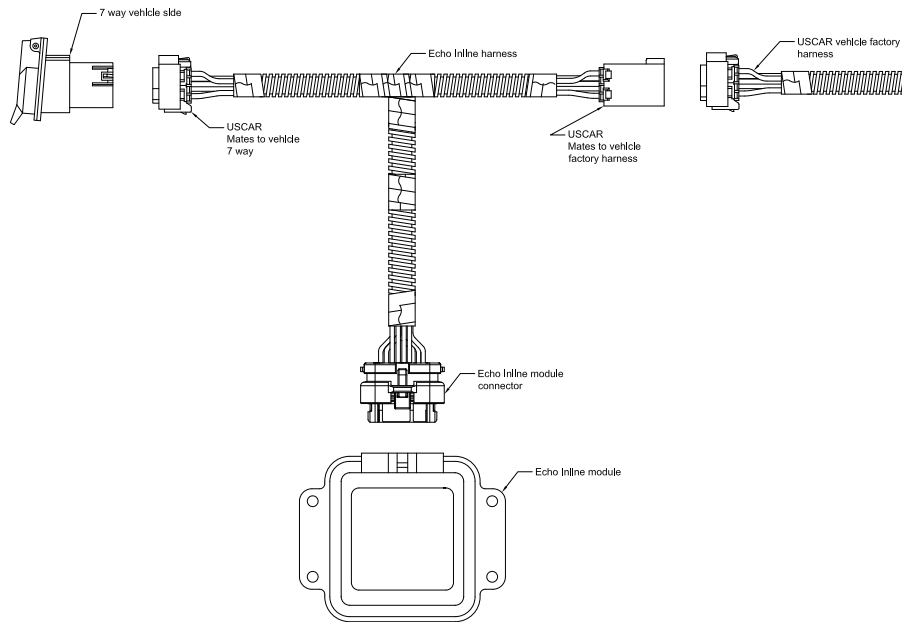

MOUNTING THE MAIN MODULE

1. Locate the vehicle 7-way electrical trailer connection at the rear of the vehicle.

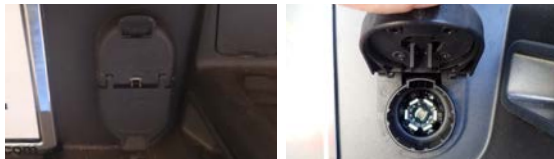

2. Some 7-way electrical connections need to be accessed from the rear of the connector or behind the vehicle bumper. The USCAR connection point has a light grey external lock. Slide the lock to the rear or towards the wires to enter the 7-way. (The lock can be completely removed from the USCAR plug.)

NOTICE Not all vehicles will have this lock depending on the year, make and model



3. Push the USCAR plug in towards the 7-way while pressing the connector lock until you feel a click, and then pull out or away from the 7-way on the USCAR connector.

NOTICE The age and use of the vehicle can cause this connection to be harder to remove than other vehicles.



4. Install the T end of the harness in between the USCAR factory wiring harness and the vehicle 7-way. Then install the Echo in-line harness connection into the main module port.

NOTICE You may notice the Echo in-line will start blinking. This means that the vehicle has 12-volt power to the 7-way at all times and can be disregarded. Some vehicles must be started and others will need to have a trailer connected. Before the 12-volt power is turned on, secure the trailer to the electrical connector at the rear of the vehicle and tap the brakes to turn on the trailer tow mode.

5. Locate a suitable mounting location for the Echo in-line unit that is sheltered from road debris. Clean all dirt and debris from the mounting surface. Using the double-sided adhesive, apply the Echo in-line to the mounting surface. Use the self-tapping screws or the provided zip ties to firmly secure the Echo unit to the mounting surface.

NOTICE The Echo in-line can be mounted in any orientation, but it must be mounted in a solid location so no movement between the unit and the mounting surface can be felt.

CAUTION Check for miscellaneous items that may be hidden behind or under any surface before using self-tapping screws to avoid damage and / or personal injury

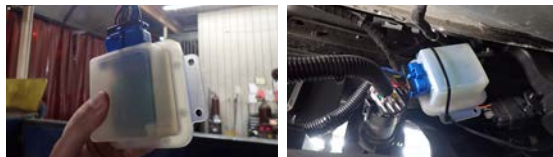

6. Using the provided zip ties, secure any excess wire harness and factory wiring to prevent snags and / or unwanted wear on electrical items.

DOWNLOAD THE MOBILE APPLICATION

Mobile applications are available for Apple and Android OS. They can be accessed in the App Store or Google Play by scanning the respective QR code below or searching for 'OneControl® Auto'.

- Apple OS Requires iOS 14 or higher
- Android OS requires Android 9.0 or higher
- Bluetooth must be enabled on your device for pairing to occur
- After the app is installed, follow the prompts for setup



INITIAL SETUP FOR BLUETOOTH CONNECTION

NOTICE The vehicle needs to be running or the ignition in the 'ON' position with the vehicle in park.

NOTICE At any moment during setup, if the LED on the Echo in-line is red, stop and refer to the 'Troubleshooting Guide'.

1. Enable Bluetooth in your mobile device settings. This will allow you to detect your Echo® device.

NOTICE Pairing of the app to the Echo device will happen within the app. Device **should not be paired** within the smartphone's Bluetooth settings menu.

2. Open the app after installation and follow the on screen prompts, agree to the end user agreement and complete the initial registration

Once registration is created, you will utilize the credentials for future logins.

3. Once registered and logged in, select 'Pair Device' under the Echo® brake icon on the home screen.
4. Prior to scanning for an Echo® brake device, grant location permissions to the app and enable device location.
5. The app will begin scanning for an Echo® device. Once the 'Echo® Brake Controller' is visible, select it. Once detected, select 'Connect' to pair the device. You will then be prompted to enter the six-digit PIN, found on the bottom of the brake controller unit or on the provided quick reference card. Once pairing is complete, you will receive a pairing successful notification and the LED light on the Echo® device will be solid blue.

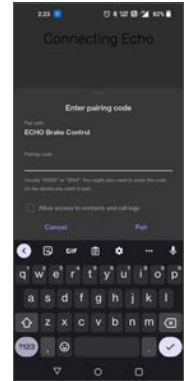
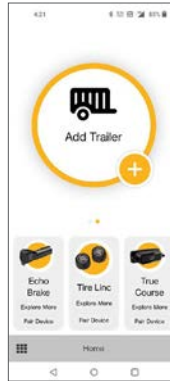

APPLICATION SETUP

After pairing with the Echo®, you will be directed to the 'Controller Profiles' to setup your trailer's profile. You can create and save profiles for multiple vehicles, trailers and load conditions.

Note: Setting configuration is required when trailer conditions change or if the brake controller is being used for a different trailer / vehicle.

Controller Profile

- In this menu, you can access the five most recently used settings. These settings are stored within the Echo® device. This option allows you or others who borrow your Echo® to access pre-configured tow settings quickly and easily.
- Your active profile will display in the foreground within the active orange circle.

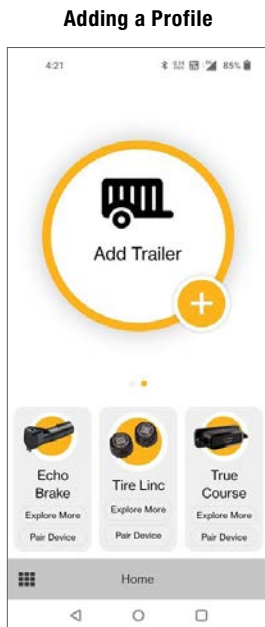

Activating a Profile

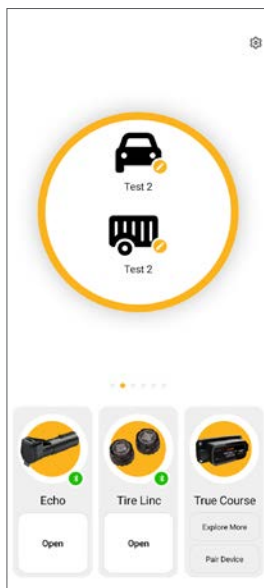

ADDING A PROFILE

1. Select the '+' symbol in the orange controller profile menu.
2. Now you will be able to modify the description of your vehicle and trailer.
3. Click 'OK' to confirm.
4. You are also able to modify an existing trailer name by swiping left on the profile.
5. Repeat steps 1 – 3 for additional trailers.

ACTIVATING A PROFILE

1. You can switch between different profiles by swiping left or right on the active controller profile on the home screen.
2. Once the chosen profile is set to active, select 'Open' under the connected Echo® device.

MODIFYING OR DELETING A PROFILE

1. Select the profile you would like to delete by swiping left or right.
2. Select the pencil or 'edit' icon next to the tow vehicle or trailer icons to enter settings.
3. If you would like to modify the profile, change the respective tow vehicle name or trailer name and select 'OK'.
4. If you would like to delete the profile, select 'Delete Profile' and select 'OK'.

Modifying / Deleting Profile

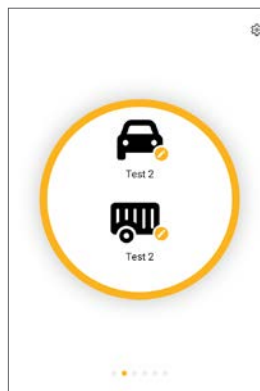

Settings

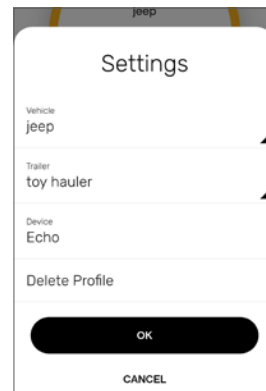

CONFIGURING PROFILE SETTINGS

To enter 'Active Profile', tap the 'Open' button shown under the image of Echo®. In your 'Active Profile' screen, you can adjust settings and use the Echo® Brake controller.

1. Manual Brake Activation

Activate manual braking, press and hold the orange button.

Manual brake controller activation is used in situations where a slow reduction in speed is desirable. As the manual control is activated, the Echo® begins to apply the trailer brakes. Manual output can be activated by pressing and holding the orange button in the app.

2. Brake Output Indicator

The orange outer ring indicates current brake output level.

The orange outer ring is a visual indicator of the current level of power being applied to the trailer brakes. When the vehicle's brakes are fully applied, the level of power and position of the ring is determined by your max output setting.

3. Max Output

The maximum level of the brake controller.

The output control establishes the max amount of power available to the trailer brakes when braking. The output should be adjusted during initial setup, when trailer load changes, when different trailers are used or when adjustment is needed for changing road or driving conditions. To edit, tap the maximum output button and increase or decrease using the '+' or '-' buttons.

4. Sensitivity Level

The sensitivity of the braking power.

The sensitivity level adjusts trailer aggressiveness when activated during braking. Sensitivity adjustment has no effect on the manual brake control. The sensitivity can be adjusted for individual driver preference, trailer load changes or changing road conditions. To edit, tap the sensitivity button and increase or decrease using the '+' or '-' buttons.

5. Vehicle Hazard Lights

Turn on any time the vehicle's hazard lights are active.

When the vehicle's hazard lights are activated, the trailer brakes may pulse on and off as the lights flash. To prevent pulsing brake output, toggle the switch ON any time the vehicle's hazard lights are active.

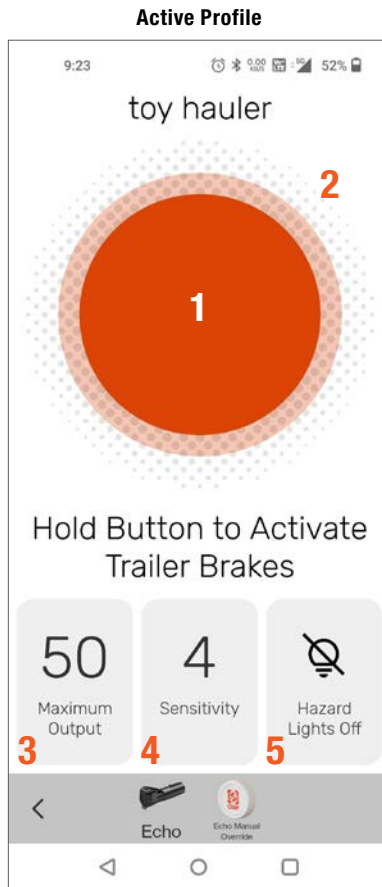

TEST DRIVE & ADJUSTMENT

Both the output and sensitivity can be adjusted to achieve smooth, firm stops. Output and sensitivity adjustments should only be made while stopped, with the transmission in park or neutral, parking brake applied, foot off the brake pedal, and no manual control actuation.

⚠ WARNING Perform tests and adjustments in a safe environment (parking lot or in minimal traffic area).

Starting with the output adjustment, drive forward on a dry and level paved or concrete surface. At approximately 25 mph, apply the vehicle's brakes. If trailer braking is insufficient, increase the max output setting in the OneControl® app. If the trailer brakes lock up, decrease the max output. Repeat this process until stops are firm, just short of lock up.

Once the output is set, adjust the sensitivity by driving forward at approximately 25 mph and press the brake pedal. The vehicle and trailer should make a smooth stop. If the stop seems slow and more aggressive braking is desired, increase the sensitivity level through the OneControl® app. If the stop seems too aggressive, decrease the sensitivity level in the app.

Make several stops at various speeds and adjust the sensitivity until stops are smooth and firm. Slight adjustment to the output control may also be required to achieve desired results at all test speeds. **Note:** If any problems occur during setup, refer to the 'Troubleshooting Guide' on the last page of this manual.

⚠ WARNING This process must be repeated if there are any changes to weather / road conditions or significant changes in trailer weight or towing setup.

LED STATUS INDICATOR

A single LED on top of the Echo® shows the status of the brake controller unit. Refer to the icons and descriptions below.



Device not paired,
no trailer connected
(flashing blue)



Device paired,
no trailer connected
(solid blue)



Calibrating
Echo®
(flashing yellow)



Device not paired,
trailer connected
(flashing green)



Device paired,
trailer connected
(solid green)



Wiring error
(flashing red)



Hardware fault
(solid red)



No power
(no light on)

Indicator	Status
Flashing blue	Device not paired, no trailer connected
Solid blue	Device paired, no trailer connected
Flashing yellow	Calibrating Echo
Flashing green	Device not paired, trailer connected
Solid green	Device paired, trailer connected
Flashing red	Wiring error
Solid red	Hardware fault

TROUBLESHOOTING GUIDE

Condition	Problem Cause	Possible Solution
LED does not light	No power to brake controller, no ground on vehicle 7-way	Check vehicle power and ground wiring Trailer mode not activated for vehicle Some vehicle's require a trailer to activate 7-way power. If a trailer is not available, the CURT 7-way tester #58272 may be used to complete setup / troubleshoot
Unable to connect to mobile devices	No power to brake controller, no ground on vehicle 7-way Invalid Bluetooth PIN Reset Bluetooth connection	Check Echo LED status for power Input PIN from label or quick reference card. Enable Bluetooth or grant permissions. Check smartphone compatibility Select trailer profile, tap the Echo device name, then tap the trash can icon to remove. In OS Settings, go to Bluetooth connections and 'forget the device'
Solid red LED for more than 10 seconds	Hardware fault	Contact CURT Product Support
Flashing red LED	Contamination in trailer plug socket	Check for clean and dry trailer plug
	Short in trailer brake wiring	Locate and correct short
	Accelerometer error	Unplug the brake controller and plug it back in
	Short or overload in trailer brakes	Troubleshoot trailer brake circuit per brake manufacturer's instructions
No trailer brakes, pedal or manual	Mis-wired 7-way connector Improper or corroded trailer wiring Weak or missing ground	Confirm vehicle and trailer 7-way connections
⚠ DANGER No trailer brakes (pedal or manual) and app signals 'disconnect'	Loss of trailer connection, unplugged or bad wiring	Confirm vehicle and trailer 7-way connections
No response on manual override or brake output	Mis-wired 7-way connector Improper or corroded trailer wiring No or intermittent power to controller Weak or missing ground Wireless connectivity error	Confirm vehicle and trailer 7-way connections Check Bluetooth and application settings
Reduced braking power on manual override or brake output	Weak or missing ground Improper max power or sensitivity settings Improper or corroded trailer wiring	Confirm vehicle and trailer 7-way connections Check Bluetooth and application settings Increase max power or sensitivity settings
Trailer brakes on all the time (LED is red)	Mis-wired 7-way trailer connector	Confirm vehicle and trailer 7-way connections
App signals 'low voltage'	Low battery voltage	Check vehicle battery and replace if needed Confirm vehicle 7-way connections and wiring
⚠ WARNING App signals 'overload'	Trailer brakes are overloaded	Reconnect the trailer connector Confirm vehicle 7-way connections and wiring Check trailer brake wiring for short circuits
NOTICE Screen	If a communication error occurs between the app and the brake controller, condition notifications from controller will not be sent	The brake controller will continue to function properly at the most recently programmed settings and braking operation will not be affected

PRODUCT REGISTRATION

CURT stands behind our products with industry-leading warranties.

Provide feedback and help us to improve our products by registering your purchase at curtmfg.com/registration.

LET US KNOW WHAT YOU THINK!

Share the love and your experience with Echo by leaving a review on curtmfg.com/51200.